



# COFFRAL

The Access Specialists!



AERIAL PLATFORMS

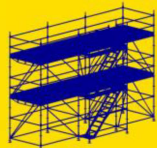

INDUSTRIAL RINGLOCK



GONDOLA



STAFLEX SHORING



SHORING JACKS



HEAVY DUTY SHORING

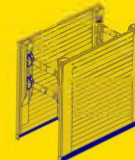

TRENCH SHORING



VERTICAL FORMWORK



CONSUMABLES



STORAGE



# Coffral Aerial Platforms

The 3rd leg of our vision to position Coffral as one-stop access solution provider for working at height is the Aerial Platforms. To keep a high-level standard in line with our other product lines, we carry JLG only as our preferred brand 'The Mercedes of Aerial Platforms.'

# Coffral Aerial Platforms Overview

## Types of Lifting Equipment:

- 1 Lifting of People, also known as Manlifts, which include:  
**Boom Lifts, Scissor Lifts, and Vertical Mast Lifts.**
- 2 Lifting Equipment, which include:  
**Telehandler.**

## Boom Lifts



Ideal for reaching difficult workspaces, areas that require maximum horizontal and vertical reach.

## Scissor Lifts



Ideal for indoor projects, more so if the project requires up-and-down mobility. Lightweight and easy-to-move equipment that allows higher load capacity and platform extension.

## Vertical Mast Lifts



Ideal for operating in narrow aisles and congested environments. These easy-to-use lift platforms offer a combination of high lift, reach, and maneuverability that makes them a safe solution for tough overhead maintenance applications.

## Telehandler



Ideal for moving loads in heavy-duty environments and operate both horizontally and vertically. The Telehandler is able to reach heights beyond the average forklift reach due to its telescopic capabilities.



## Boom Lifts

- JLG 1350SJP
- JLG 800AJ
- JLG 600AJ
- JLG 600S
- JLG 450AJ
- JLG E450AJ
- JLG E400AJPN

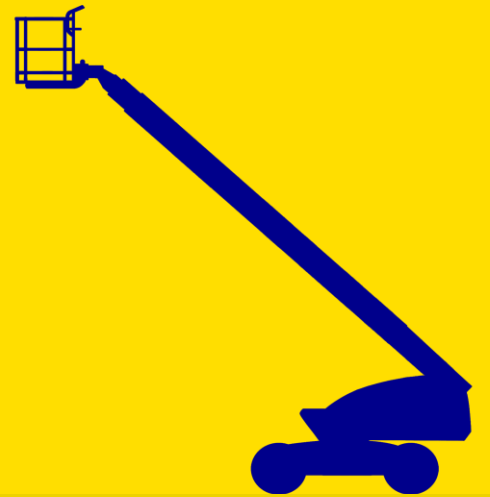



## Telescopic Boom Lift

# JLG 1350SJP

**Note:**  
Diesel Powered Boom Lifts  
can only be used outdoors.  
*All-terrain tires.*

### PERFORMANCE

Max. Reachable Height	43.30m
Horizontal Outreach	24.38m
Platform Capacity	230kg / 2 Persons
Platform Rotator (Hydraulic)	180°
Swing	360°
Jib Length	2.44m
Jib - Range of Articulation	130° Vertical
Jib Plus	180° Horizontal
Machine Weight	20,400kg
Max. Ground Bearing Pressure	7.52kg / cm <sup>2</sup>
Power Source	Diesel Engine

## Reach Diagram

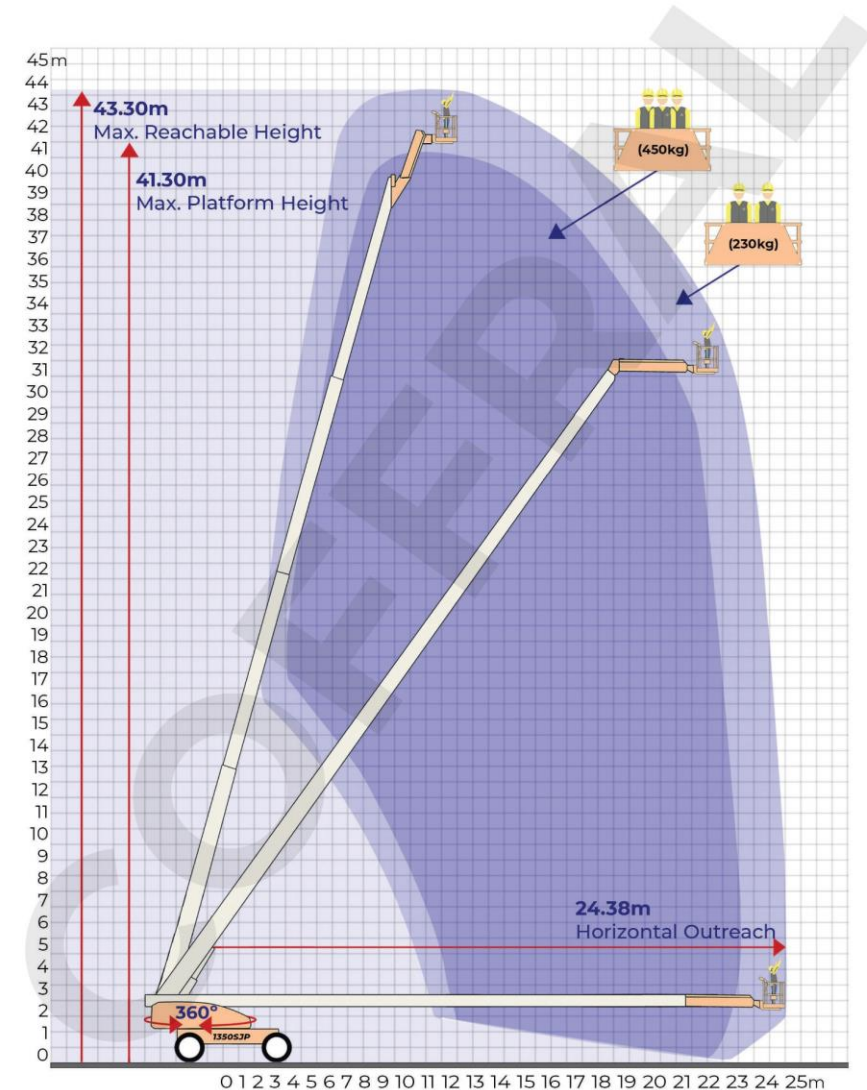



## Articulating Boom Lift **JLG 800AJ**

**Note:**  
Diesel Powered Boom Lifts  
can only be used outdoors.  
*All-terrain tires.*

### PERFORMANCE

Max. Reachable Height	26.38m
Horizontal Outreach	15.80m
Platform Capacity	230kg / 2 Persons
Platform Rotator (Hydraulic)	180°
Swing	360°
Jib - Overall Length	1.83m
Jib - Range of Articulation	130° (+70°, -60°)
Machine Weight	16,110kg
Max. Ground Bearing Pressure	5.60kg / cm <sup>2</sup>
Power Source	Diesel Engine

## Reach Diagram

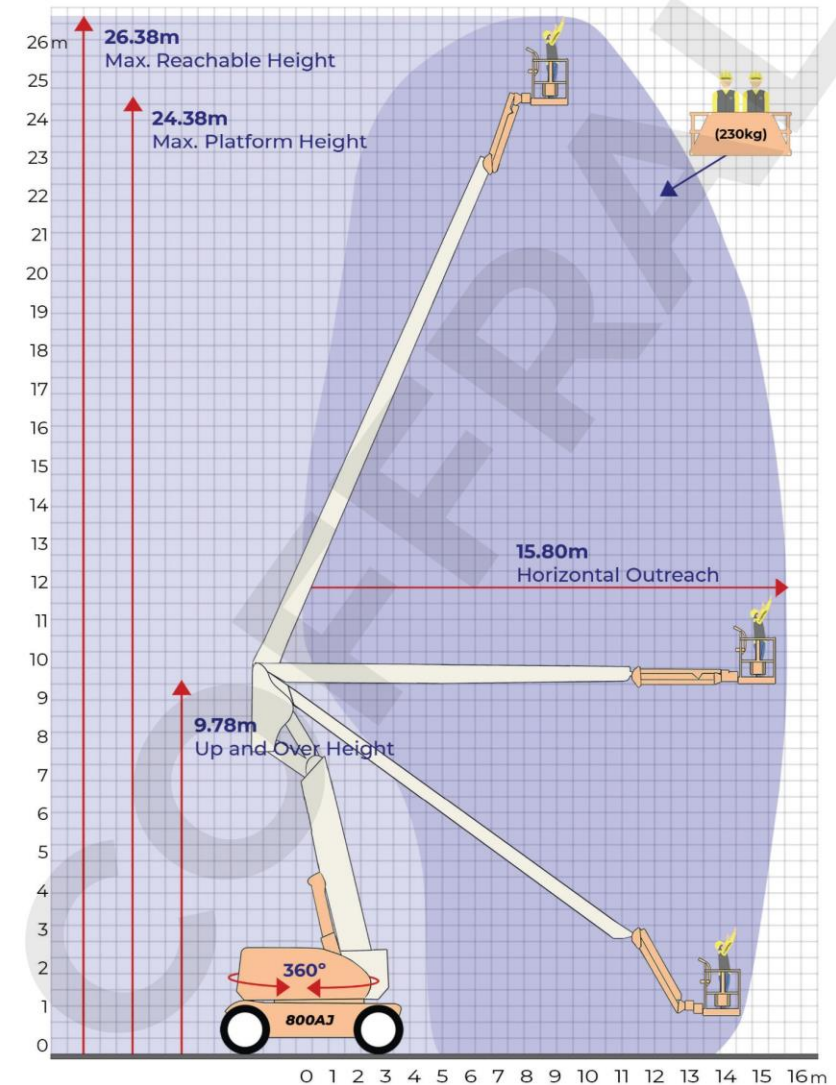



## Articulating Boom Lift **JLG 600AJ**

**Note:**  
Diesel Powered Boom Lifts  
can only be used outdoors.  
*All-terrain tires.*

### PERFORMANCE

Max. Reachable Height	20.47m
Horizontal Outreach	12.10m
Platform Capacity	230kg / 2 Persons
Platform Rotator (Hydraulic)	180°
Swing	360°
Jib - Overall Length	1.83m
Jib - Range of Articulation	130° (+70°, -60°)
Machine Weight	11,900kg
Max. Ground Bearing Pressure	5.25kg / cm <sup>2</sup>
Power Source	Diesel Engine

## Reach Diagram

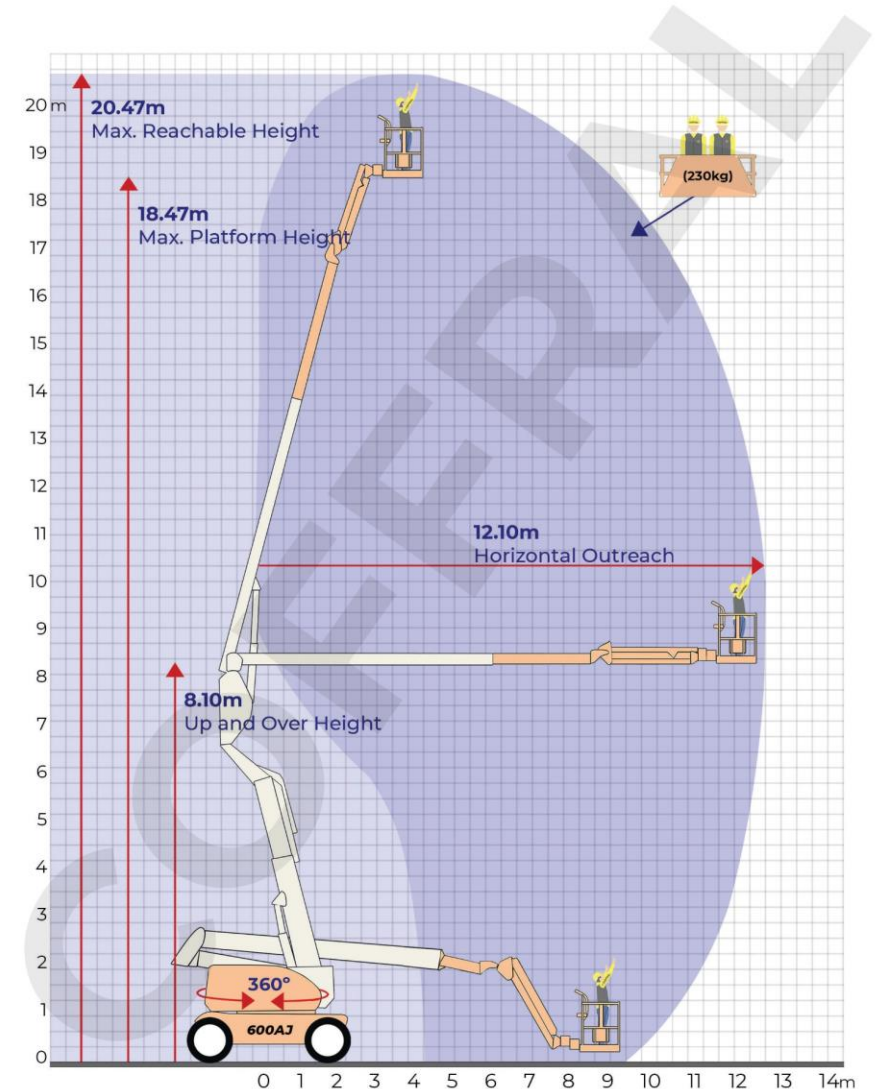



## Telescopic Boom Lift **JLG 600S**

**Note:**  
Diesel Powered Boom Lifts  
can only be used outdoors.  
*All-terrain tires.*

### PERFORMANCE

Max. Reachable Height	20.18m
Horizontal Outreach	15.29m
Platform Capacity	455kg / 3 Persons
Platform Rotator (Hydraulic)	160°
Swing	360°
Jib - Overall Length	1.83m
Jib - Range of Articulation	130° (+70°, -60°)
Machine Weight	10,370kg
Max. Ground Bearing Pressure	5.81kg / cm <sup>2</sup>
Power Source	Diesel Engine

## Reach Diagram

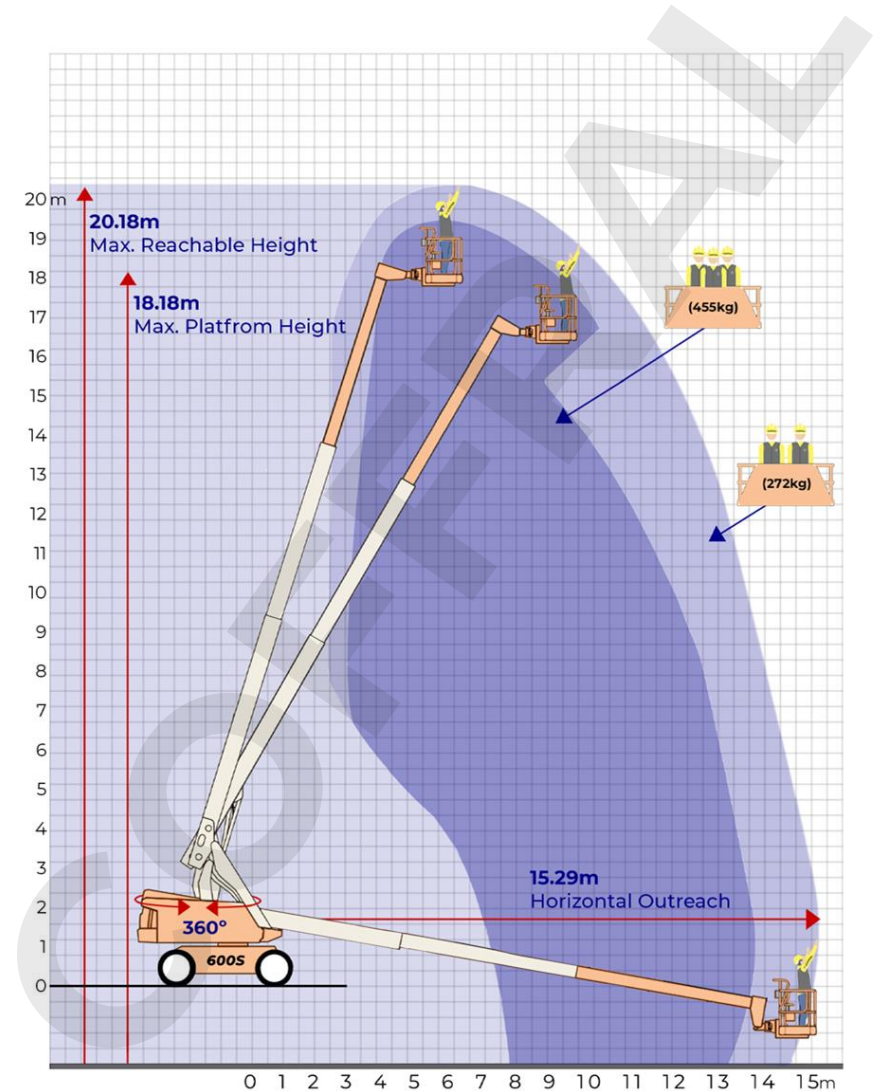





## Articulating Boom Lift **JLG 450AJ**

**Note:**  
Diesel Powered Boom Lifts can only be used outdoors.  
*All-terrain tires.*

### PERFORMANCE

Max. Reachable Height	15.72m
Horizontal Outreach	7.62m
Platform Capacity	230kg / 2 Persons
Platform Rotator (Hydraulic)	180°
Swing	360°
Jib - Overall Length	1.24m
Jib - Range of Articulation	144° (+84°, -60°)
Machine Weight	6,495kg
Max. Ground Bearing Pressure	3.37kg / cm <sup>2</sup>
Power Source	Diesel Engine

## Reach Diagram

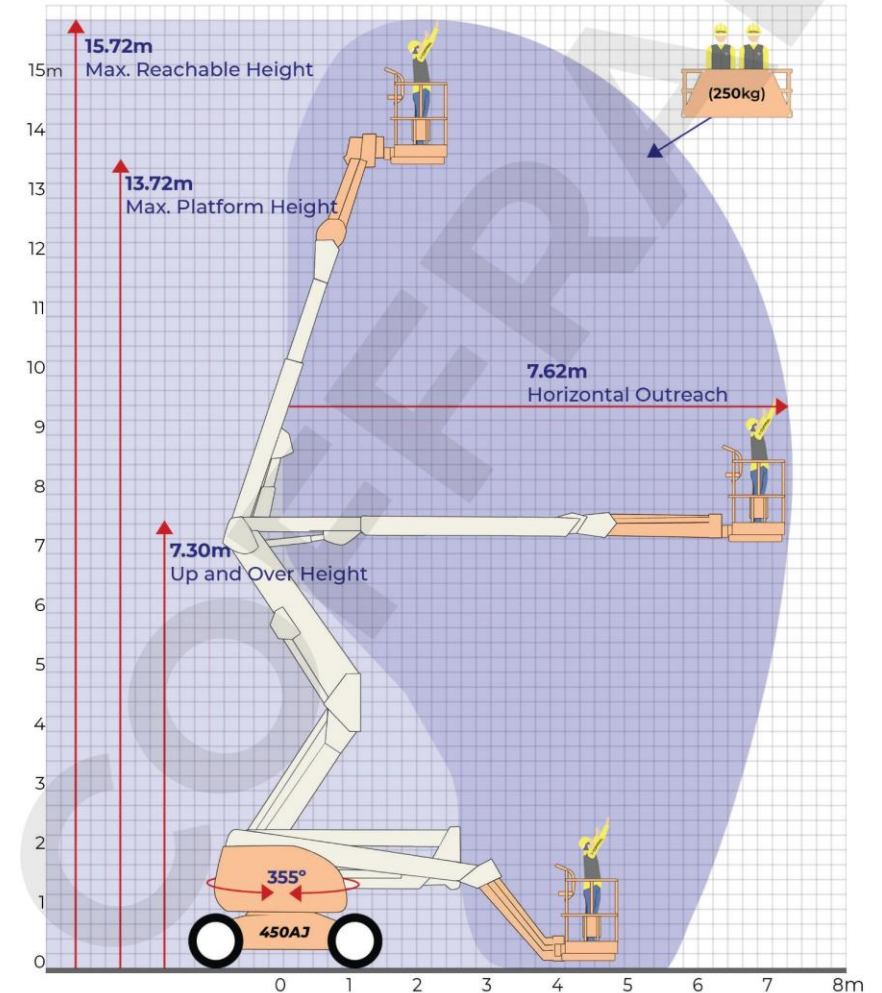



## Articulating Boom Lift **JLG E450AJ**

**Note:**  
Electric Powered Boom Lifts  
can be used indoors & outdoors.  
*Non-marking white tires.*

### PERFORMANCE

Max. Reachable Height	15.72m
Horizontal Outreach	7.24m
Platform Capacity	230kg / 2 Persons
Platform Rotator (Hydraulic)	180°
Swing	360°
Jib - Overall Length	1.24m
Jib - Range of Articulation	144° (+84°, -60°)
Machine Weight	6,670kg
Max. Ground Bearing Pressure	5.3kg / cm <sup>2</sup>
Power Source	Electric battery

## Reach Diagram

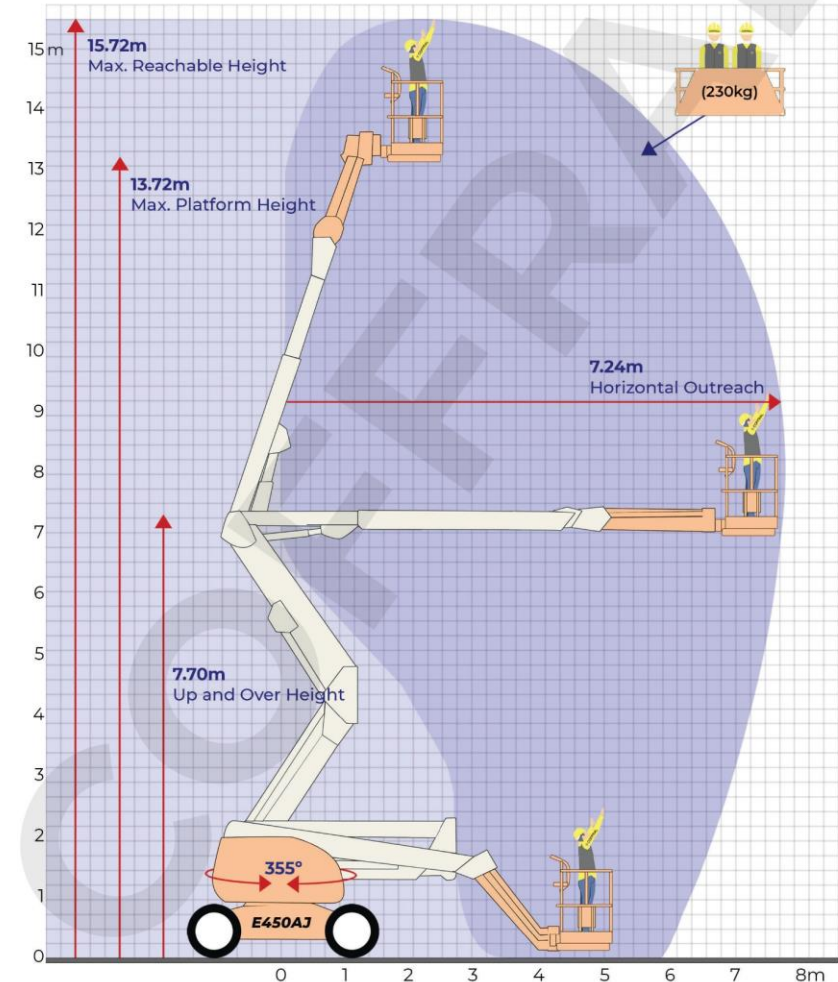



## Articulating Boom Lift

# JLG E400AJPN

### Note:

Electric Powered Boom Lifts  
can be used indoors & outdoors.  
*Non-marking white tires.*

## PERFORMANCE

Max. Reachable Height	14.19m
Horizontal Outreach	6.83m
Platform Capacity	230kg / 2 Persons
Platform Rotator (Hydraulic)	180°
Swing	360°
Jib - Overall Length	1.24m
Jib - Range of Articulation	144° (+84°, -60°)
Machine Weight	6,759kg
Max. Ground Bearing Pressure	13.0kg /cm <sup>2</sup>
Power Source	Electric battery

## Reach Diagram

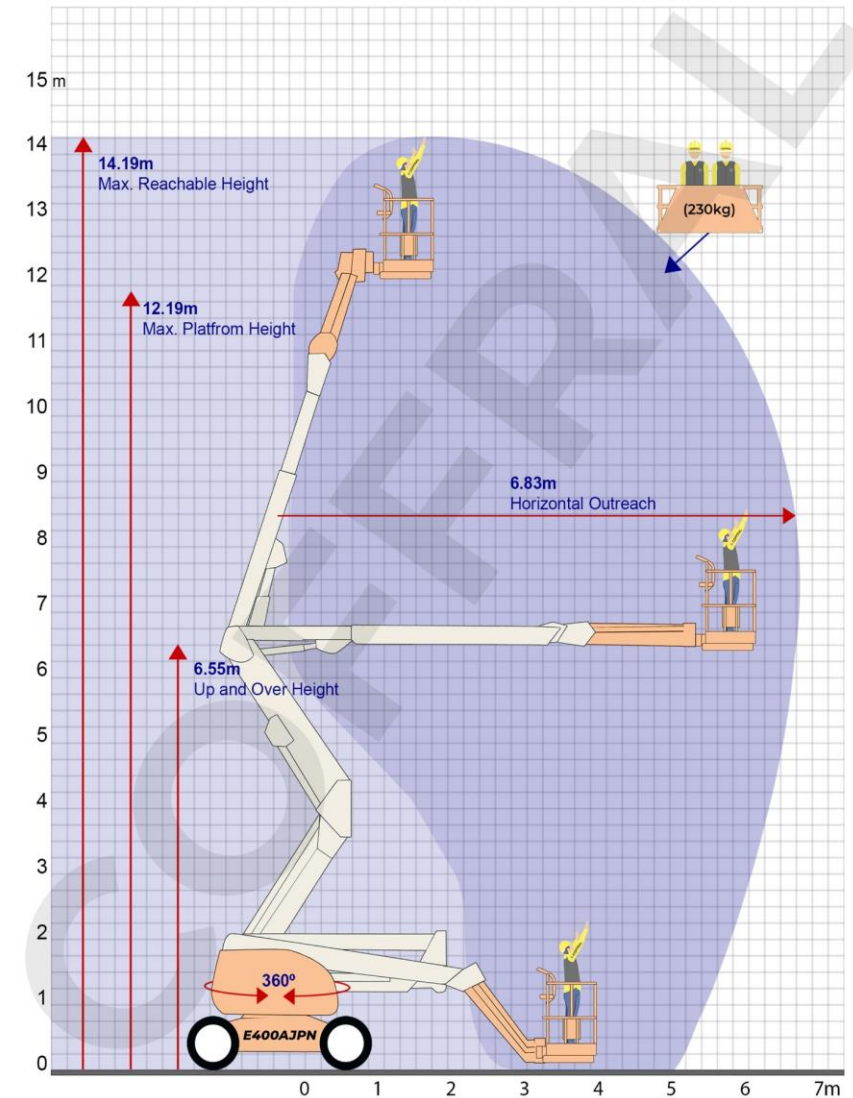



## Scissor Lifts

- JLG 4394RT
- JLG M4069
- JLG 3246ES
- JLG 2646ES
- JLG 2030ES
- JLG 1930ES

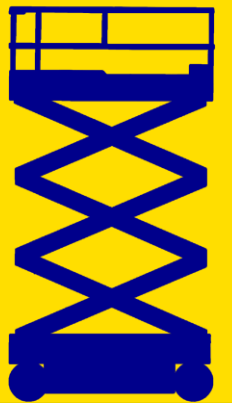



## Scissor Lift

# JLG 4394RT

**Note:**  
Can only be used outdoor.  
*All-terrain tires.*

### PERFORMANCE

Max. Reachable Height	15.11m
Platform Capacity (unrestricted)	565kg / 3 Persons
Platform Size	2.18 x 3.81m
Platform Extension Length	1.22m
Platform Extension Capacity	225kg / 2 Persons
Machine Width	2.39m
Machine Length	2.50m
Machine Height	2.36m
Machine Weight	7,100kg
Max. Ground Bearing Pressure	6.98kg / cm <sup>2</sup>
Power Source	Diesel Engine

### Reach Diagram

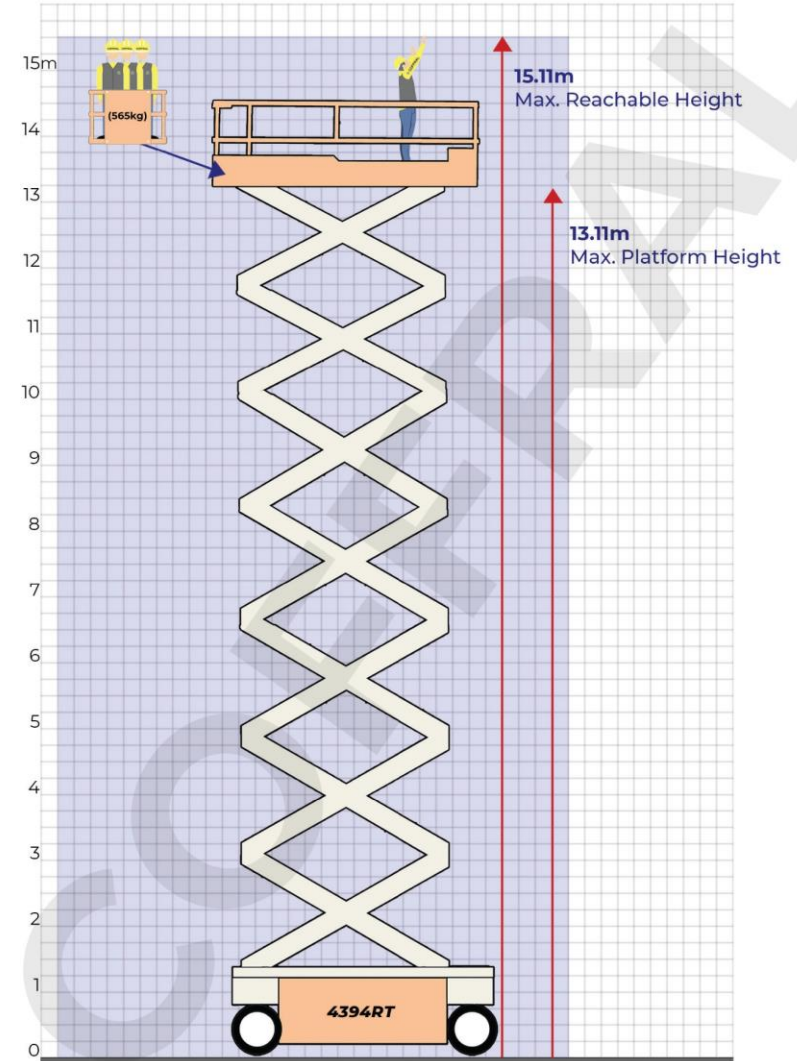



## Electric Scissor Lift

# JLG M4069

### Note:

Can be used indoor and outdoor. When used outdoors, Reachable Height and Lifting Capacity are limited.

*Non-marking tires for flat tile or concrete flooring only.*

## PERFORMANCE

Max. Reachable Height	14.19m
Platform Capacity (unrestricted)	360kg / 3 Persons
Platform Size	1.65 x 2.92m
Platform Extension Length	0.91m
Platform Extension Capacity	120kg / 1 Person
Machine Width	1.75m
Machine Length	2.50m
Machine Height	2.36m
Machine Weight	5,700kg
Max. Ground Bearing Pressure	6.98kg / cm <sup>2</sup>
Power Source	Electric battery

## Reach Diagram

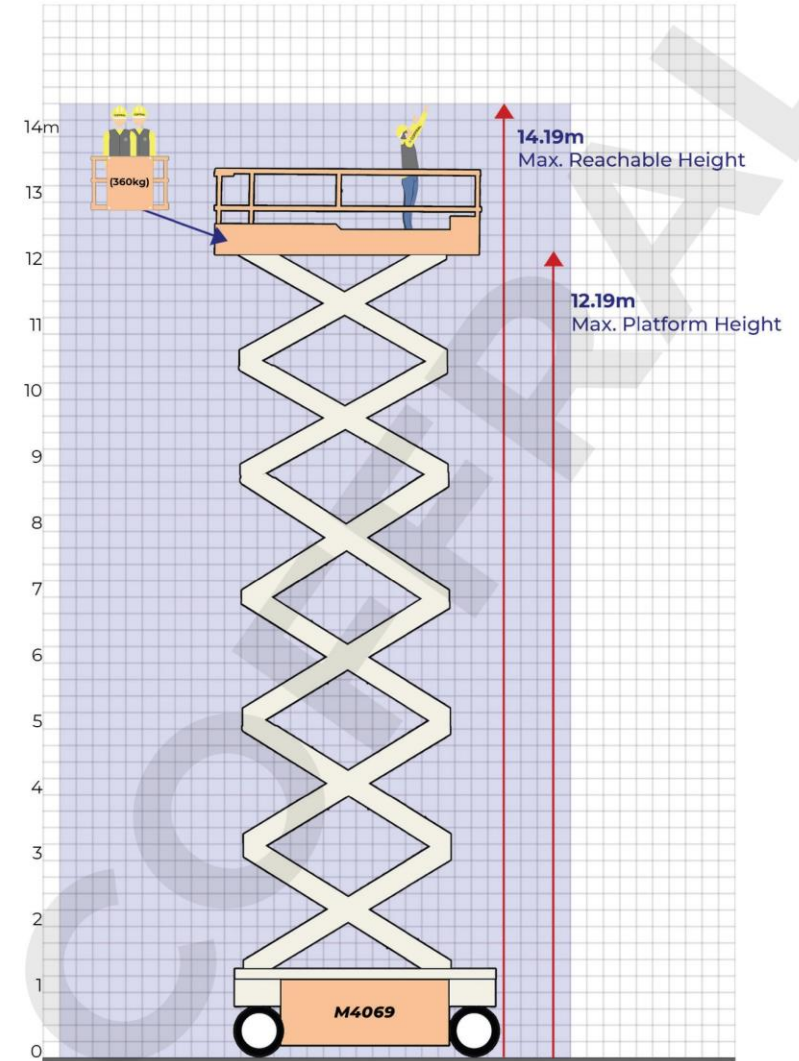



## Electric Scissor Lift

# JLG 3246ES

### Note:

Can be used indoor and outdoor. When used outdoors, Reachable Height and Lifting Capacity are limited.

*Non-marking tires for flat tile or concrete flooring only.*

### PERFORMANCE

Max. Reachable Height	11.68m
Platform Capacity (unrestricted)	320kg / 3 Persons
Platform Size	1.12 x 2.50m
Platform Extension Length	1.27m
Platform Extension Capacity	120kg / 1 Person
Machine Width	1.17m
Machine Length	2.50m
Machine Height	2.36m
Machine Weight	2,905kg
Max. Ground Bearing Pressure	6.98kg / cm <sup>2</sup>
Power Source	Electric battery

### Reach Diagram

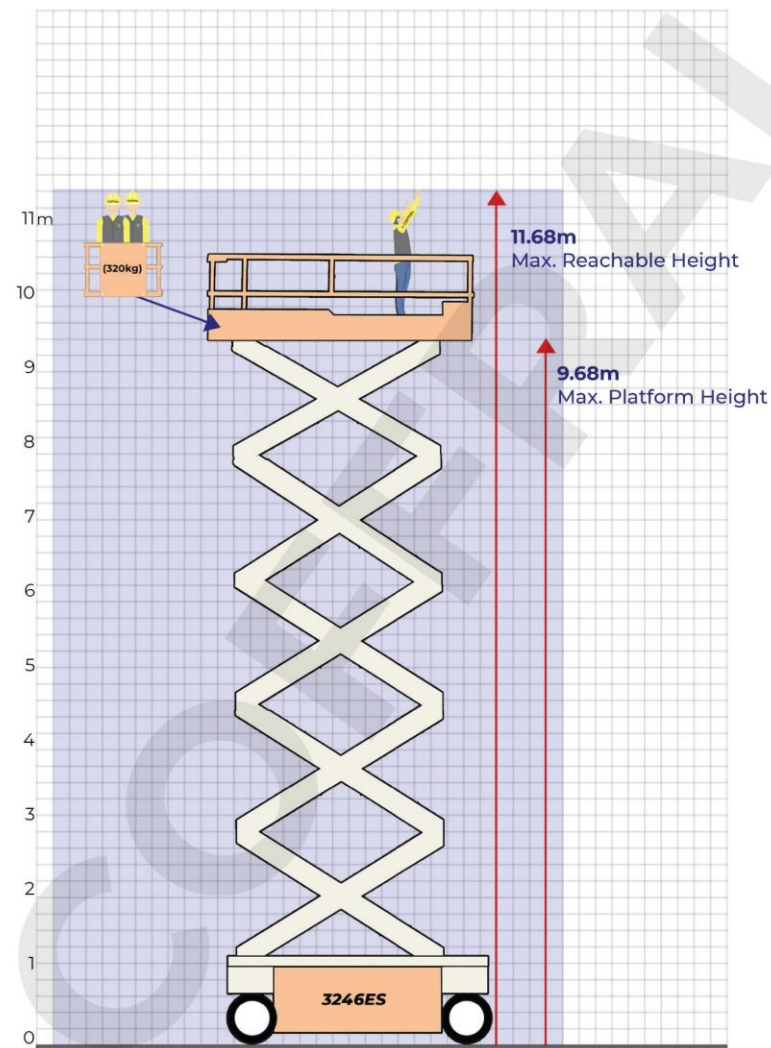



## Electric Scissor Lift

# JLG 2646ES

### Note:

Can be used indoor and outdoor. When used outdoors, Reachable Height and Lifting Capacity are limited.

*Non-marking tires for flat tile or concrete flooring only.*

## PERFORMANCE

Max. Reachable Height	9.92m
Platform Capacity (unrestricted)	450kg / 3 Persons
Platform Size	1.12 x 2.50m
Platform Extension Length	1.27m
Platform Extension Capacity	120kg / 1 Person
Machine Width	1.17m
Machine Length	2.50m
Machine Height	2.39m
Machine Weight	2,740kg
Max. Ground Bearing Pressure	6.98kg / cm <sup>2</sup>
Power Source	Electric battery

## Reach Diagram

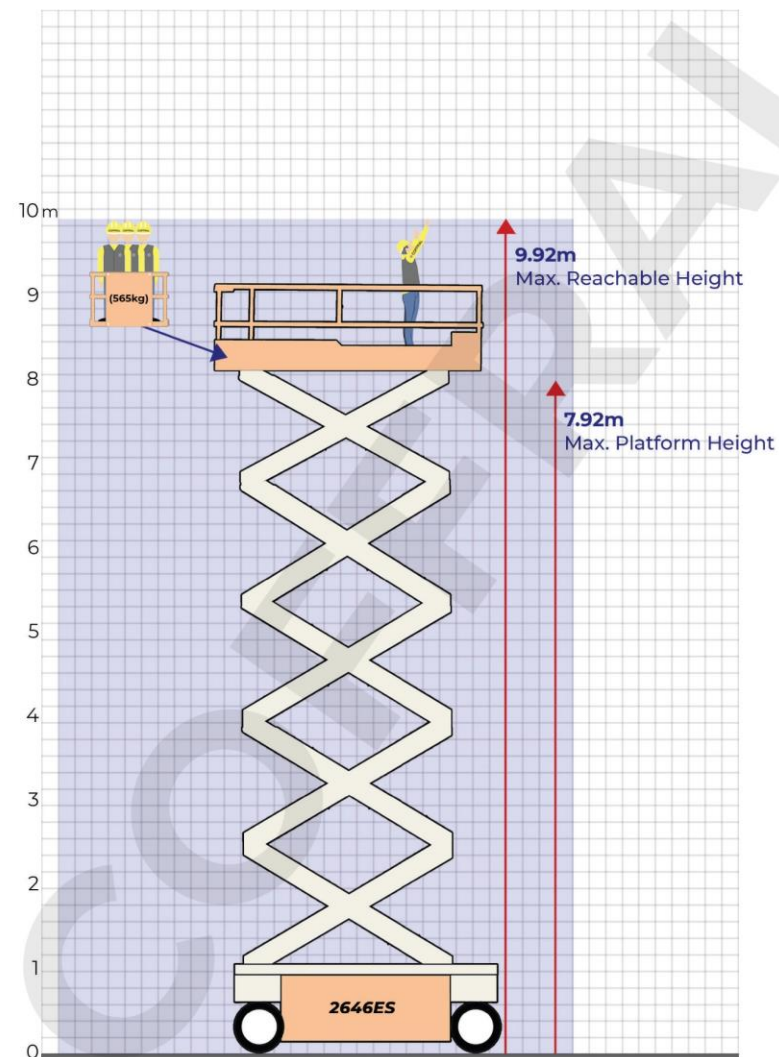





## Electric Scissor Lift

# JLG 2030ES

### Note:

Can be used indoor and outdoor. When used outdoors, Reachable Height and Lifting Capacity are limited.

*Non-marking tires for flat tile or concrete flooring only.*

### PERFORMANCE

Max. Reachable Height	8.10m
Platform Capacity (unrestricted)	360kg / 2 Persons
Platform Size	0.76 x 2.30m
Platform Extension Length	0.90m
Platform Extension Capacity	120kg / 1 Person
Machine Width	0.76m
Machine Length	2.30m
Machine Height	2.20m
Machine Weight	1,970kg
Max. Ground Bearing Pressure	6.33kg / cm <sup>2</sup>
Power Source	Electric battery

## Reach Diagram

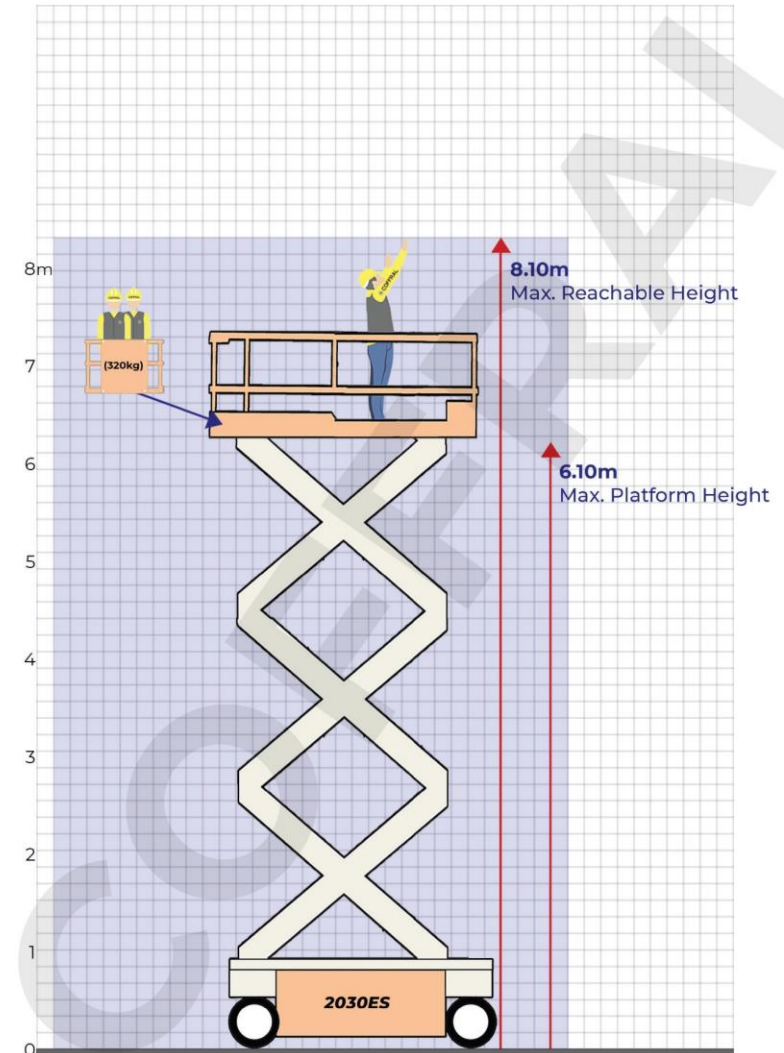



## Electric Scissor Lift

# JLG 1930ES

### Note:

Can be used indoor and outdoor. When used outdoors, Reachable Height and Lifting Capacity are limited.

*Non-marking tires for flat tile or concrete flooring only.*

### PERFORMANCE

Max. Reachable Height	7.72m
Platform Capacity (unrestricted)	230kg / 2 Persons
Platform Size	0.76 x 1.87m
Platform Extension Length	0.90m
Platform Extension Capacity	120kg / 1 Person
Machine Width	0.76m
Machine Length	1.87m
Machine Height	2.02m
Machine Weight	1,565kg
Max. Ground Bearing Pressure	8.73kg / cm <sup>2</sup>
Power Source	Electric battery

## Reach Diagram

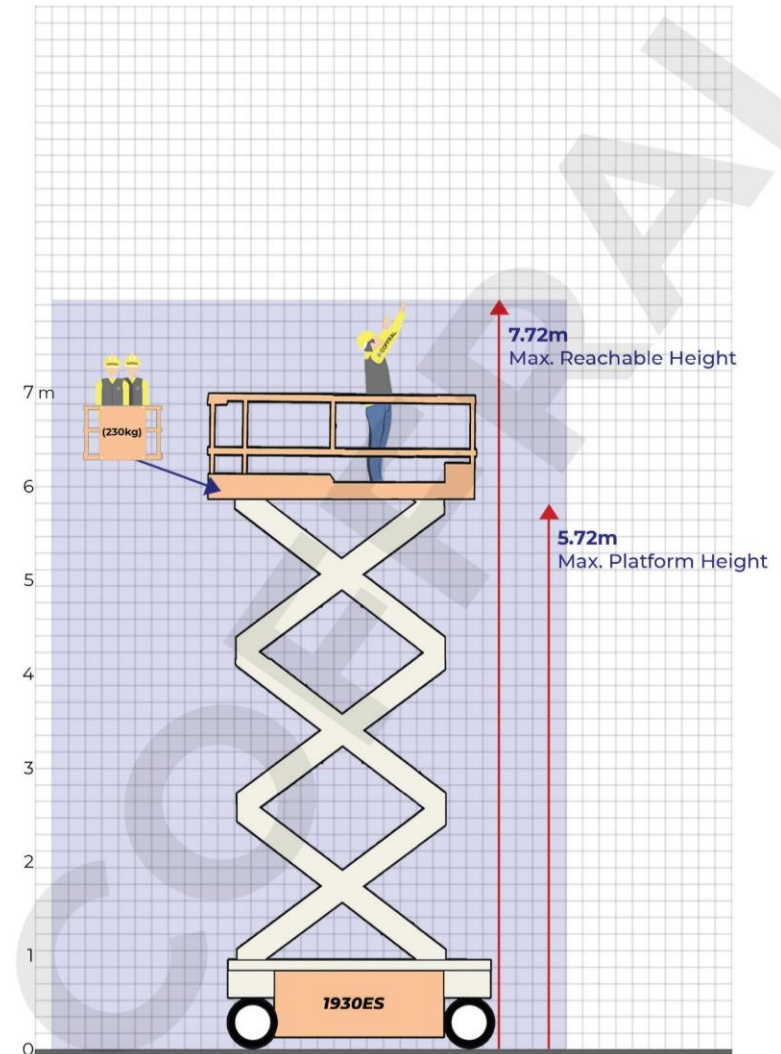



## Vertical Mast Lifts

- JLG 20MVL
- JLG Ecolift 70

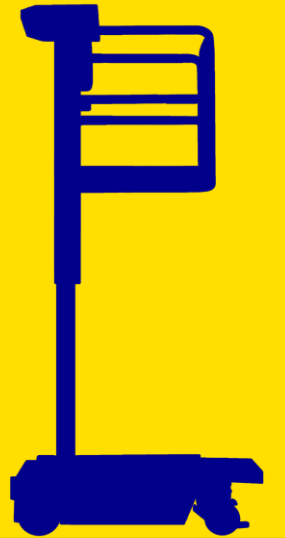



## Vertical Mast Lift **JLG 20MVL**

### Note:

Electric Powered Vertical Mast Lifts can be used indoor and outdoor.

*Non-marking tires for flat tile or concrete flooring only.*

### PERFORMANCE

Max. Reachable Height	7.68m
Maximum Lifting Capacity	159kg / 1 Person
Platform Size	0.71 x 1.22m
Stowed Height	1.98m
Stowed Width	0.75m
Stowed Length	1.38m
Machine Weight	1,060kg
Power Source	Electric Drivable

## Reach Diagram

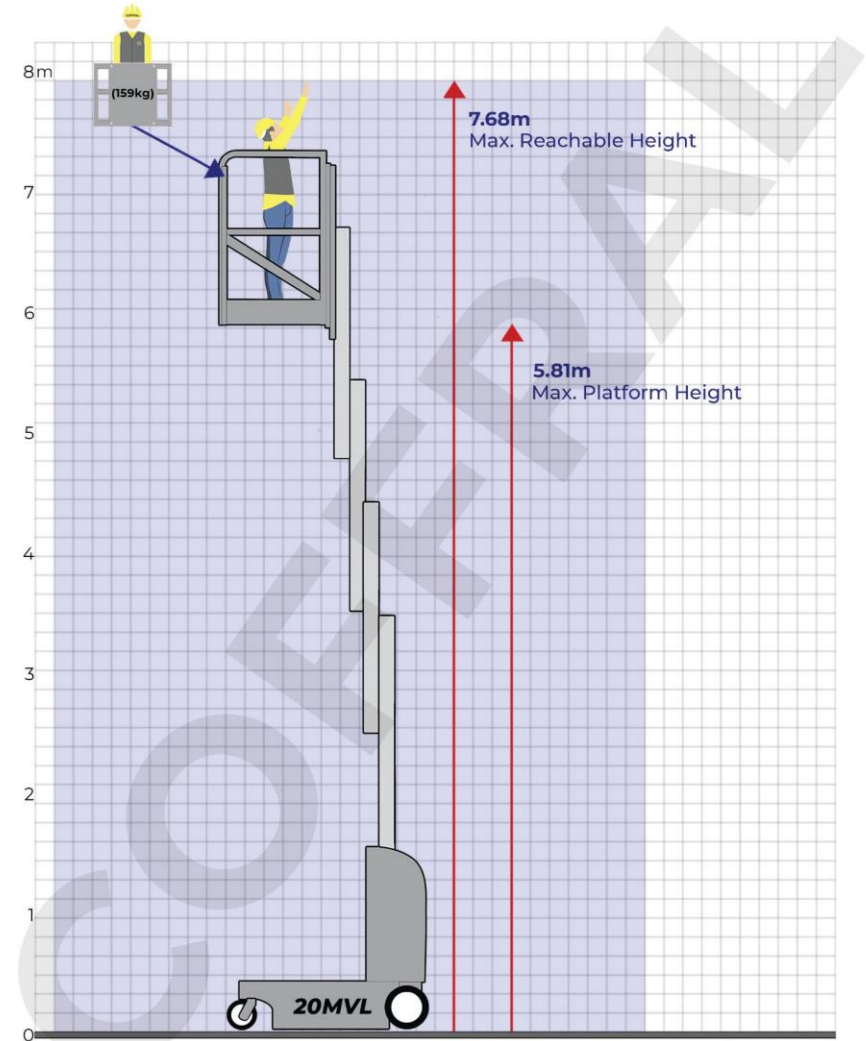



## Vertical Mast Lift

# JLG Ecolift 70

### Note:

Non-powered Vertical Lifts can be used indoors and outdoors. Mechanical, quiet, and power-free model. No electricity charging and no diesel required, fully manual.

*Non-marking tires for flat tile or concrete flooring only.*

## PERFORMANCE

Max. Reachable Height	4.20m
Maximum Lifting Capacity	150kg / 1 Person
Platform Size	0.85 x 0.64m
Stowed Height	1.94m
Stowed Width	0.70m
Stowed Length	1.28m
Machine Weight	305kg
Power Source	Manual

## Reach Diagram

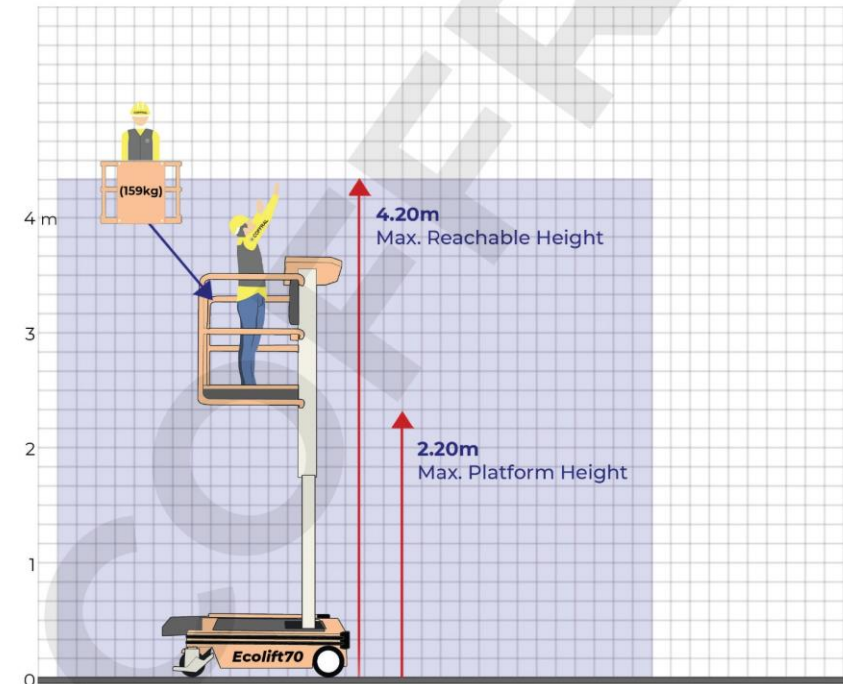



# Telehandler

- JLG 4013PS

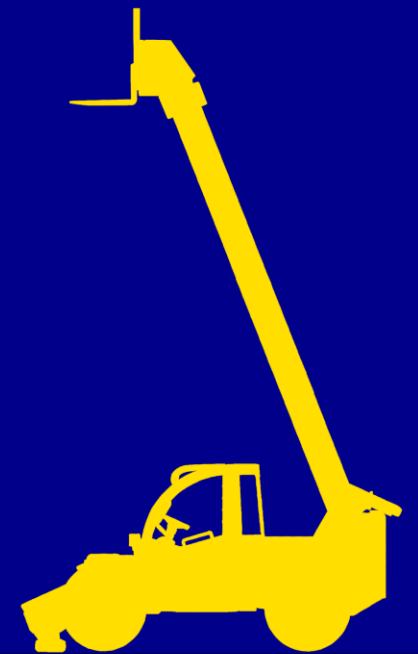



Telehandler

# JLG 4013PS

**Note:**

With activated frame leveling device, complies with EN1459.  
*All-terrain tires.*

## PERFORMANCE

Max. Lift Capacity 4,000kg

Height with Maximum Capacity 13.00m

Maximum Forward Reach 9.20m

Capacity at Max. Forward Reach 1,300kg

Breakout Force 70kN

Towing Capacity 5,000kg

Machine Length (less forks) 6.00m

Machine Height 2.45m

Machine Width 2.38m

Machine Weight 11,800kg

Power Source Diesel Engine

## Reach Diagram

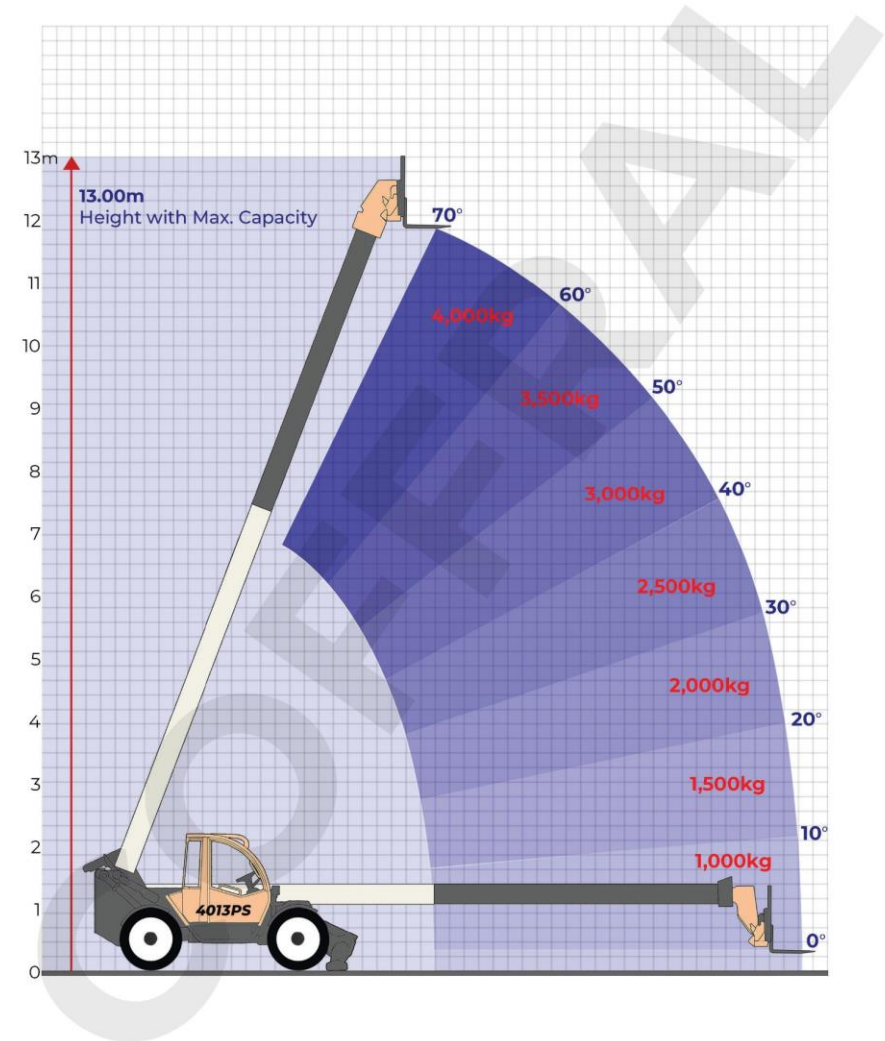

# CHAMPION PROJECTS









**600AJ**



## New Manila Int'l Airport

2022-2023 |  Bulakan, Bulacan, Luzon Region, Philippines 

**Giving access to the steel structure for warehouse construction.**



**800AJ**



## LBC Warehouse

2022 | 📍 San Dionisio, Parañaque, Philippines



**Giving access to the steel structure for warehouse construction.**



**800AJ**

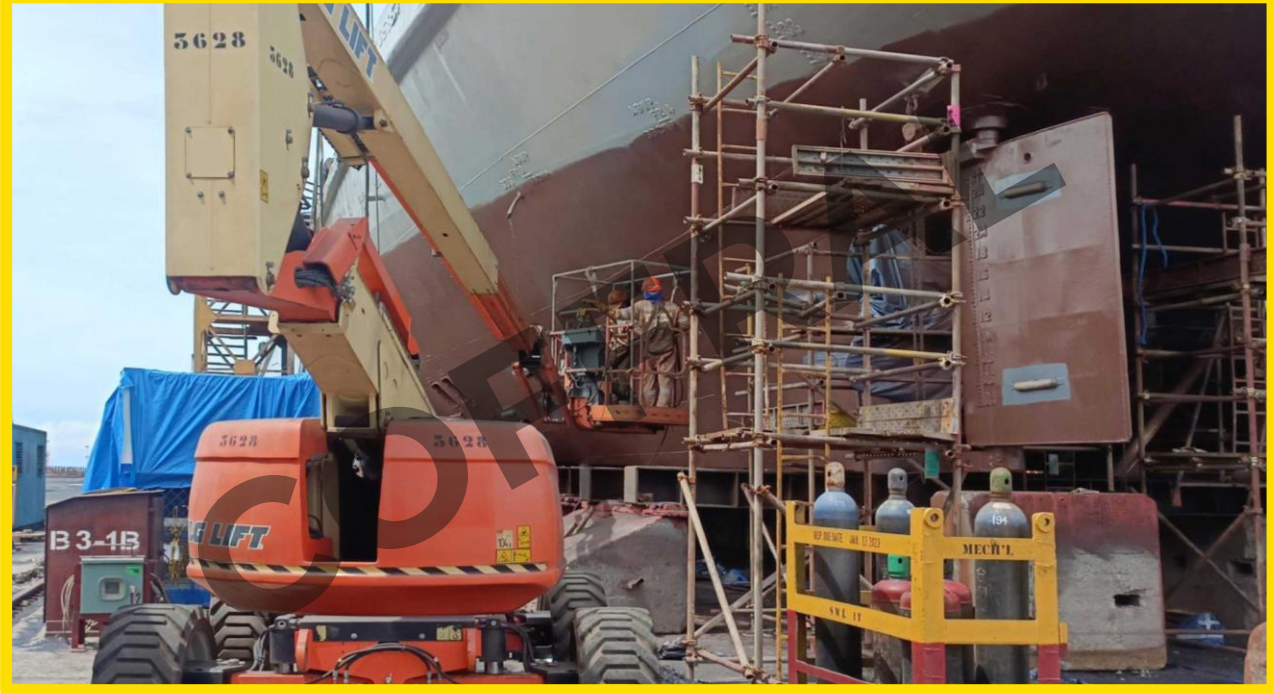

## Ship Blasting in Batangas

2022 | 📍 Keppel Batangas Shipyard 🇵🇭

Giving access using man lifts to sandblast and repaint the ship's exterior and interior.

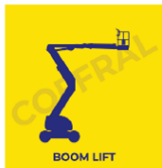

## Solar Panels Installation

2022 | 📍 Asian Transmission Corp., Calamba, Laguna



Giving access to the roof for solar panels installation.



**1350SJP**



## Parklinks Bridge Construction

2021 - 2022 | 📍 Pasig, Metro Manila



**Bridge cable installation & painting at 43m height.**



**600AJ**

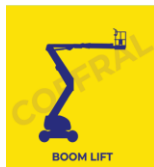

## Air Asia and Philippines Airlines Repair

2021 - 2022 | 📍 Clark International Airport, Pampanga



Aircraft maintenance repair and overhaul (MRO).



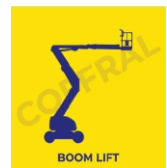

## St. Luke's Medical Center Maintenance

2021 | 📍 St. Luke's Medical Center, BGC, Metro Manila



Façade repair



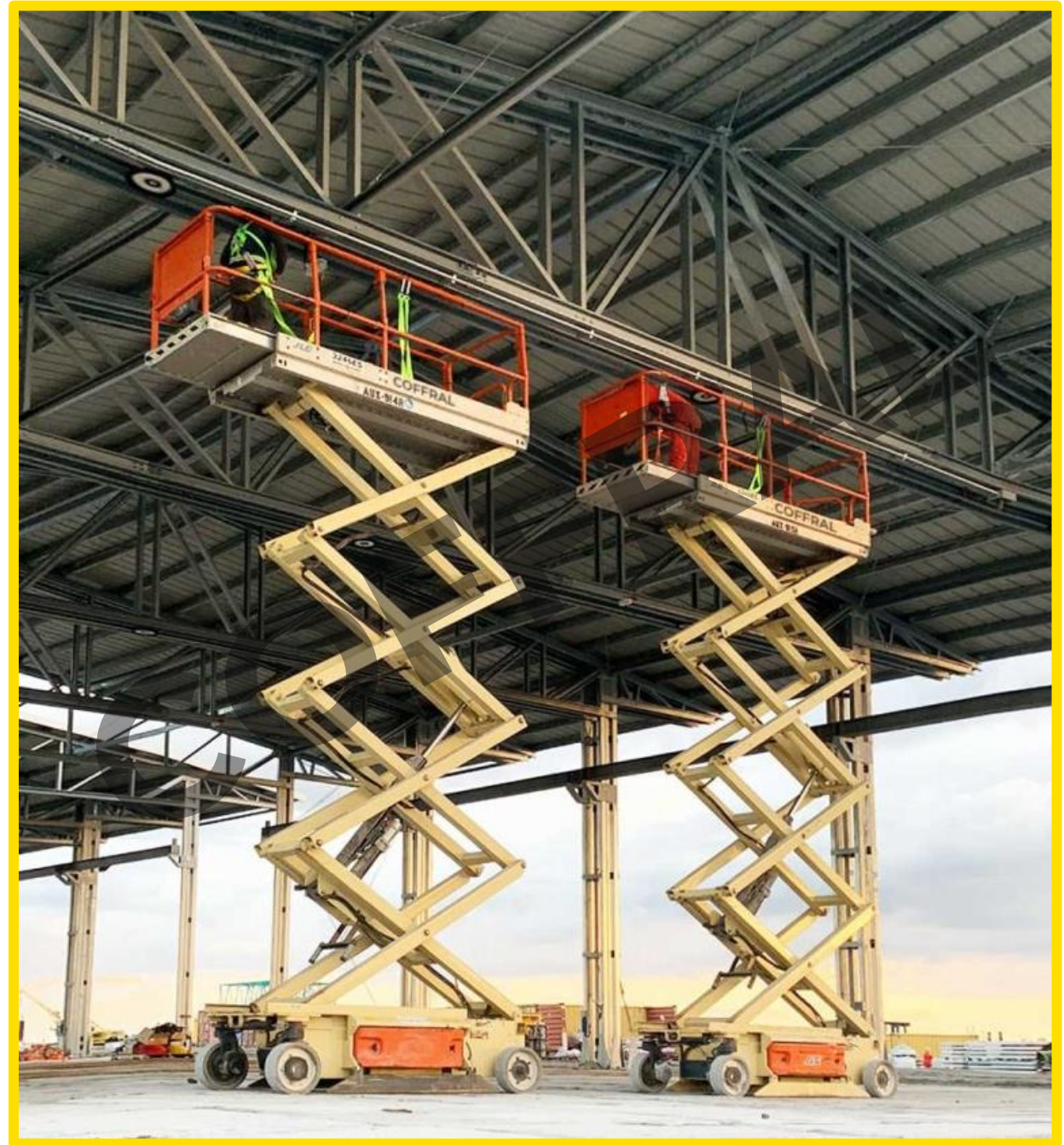

## New Manila Int'l Airport

2022-2023 |  Bulakan, Bulacan, Luzon Region, Philippines 

Giving access to the steel structure for warehouse construction.



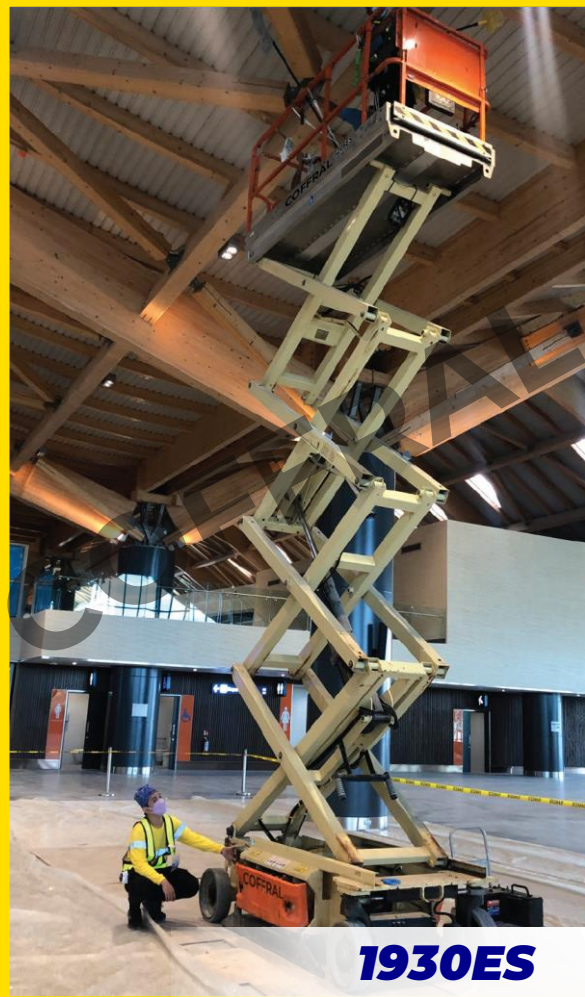

## Clark Int'l Airport New Passenger Terminal

2021 | 📍 Clark International Airport, Pampanga



Building  
annual cleaning



**2030ES**



## Malolos-Clark Railway (MCRP CPN-03)

2021 | 📍 Pampanga, Angeles 🇵🇭

**Painting and welding  
structural steel.**



**Ecolift 70**



**20MVL**

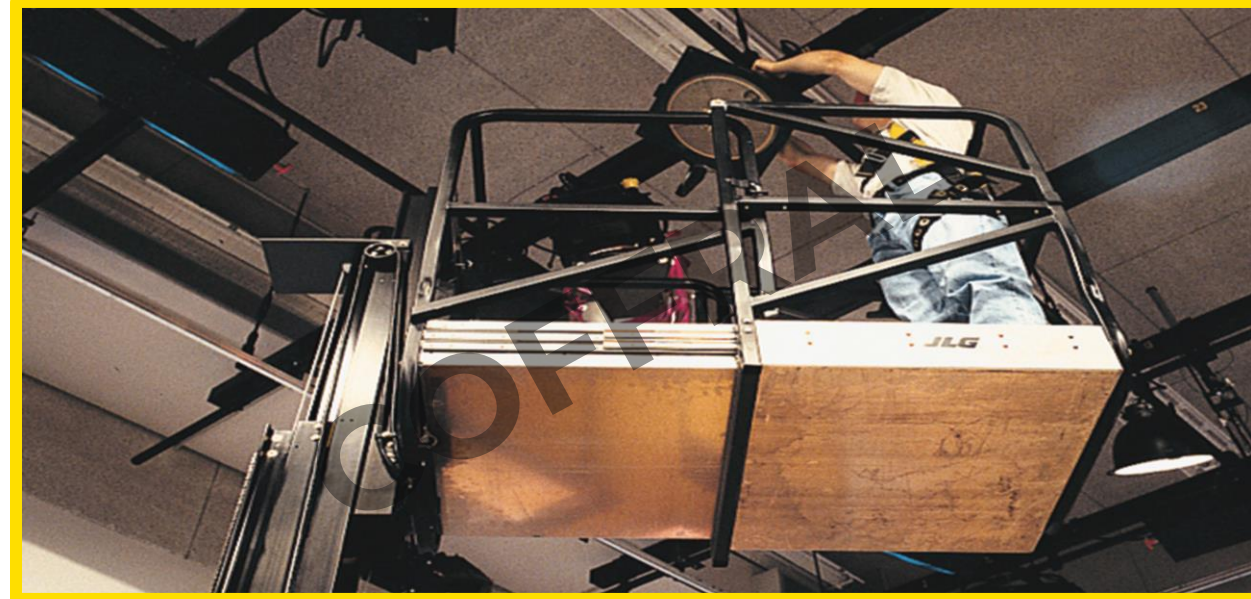

## Coffral Head Office Repair and Cleaning

2020-2021 | 📍 Unit 2701, Summit One Tower,  
530 Shaw Blvd, Mandaluyong,  
1550 Metro Manila



**Giving access to the  
ceiling for general  
cleaning, repair, and  
light bulb changes.**



**4013PS**



## Unloading of Containers

2022

Unload heavy equipment from a 40-foot container



**4013PS**



## Parklinks Bridge Construction

2021 - 2022 |  Pasig, Metro Manila



**Move equipment in heavy-duty environments**



**Coffral Certified  
Operator included**



**Coffral Mechanic Expert  
a.k.a Doctor JLG**



**Coffral Lowbed Truck  
Transportation**

# Thank you!

**COFFRAL  
ASIA**

**COFFRAL PHILIPPINES**



[www.coffral.ph](http://www.coffral.ph)

[inquiry@coffral.ph](mailto:inquiry@coffral.ph)

Unit 2701 Summit One Tower, 530 Shaw Blvd., Mandaluyong City, 1550, Philippines

**COFFRAL THAILAND**



[www.coffral.co.th](http://www.coffral.co.th)

[inquiry@coffral.co.th](mailto:inquiry@coffral.co.th)

72 soi Ratchada Niwet Yaek 3, Samsen Nok, Huai Khwang, Bangkok 10310, Thailand



FOLLOW US

[coffralasia](#)  
[coffralasia](#)  
[CoffralAsia](#)

Equipment Rental + Certified Operators + Doctor JLG

## AERIAL PLATFORMS

RENTAL SALES ENGINEERING TRAINING INSTALLATION SUPERVISION



SCISSOR LIFT



BOOM LIFT